

## INSTRUCTION TO BIDDERS

### 1.0 Bidding Procedures

- 1.1 Bidders shall bid on all line items. Each line item shall have a separate bid price. Failure to do so may be cause for rejection of the bid. Care should be exercised that the amounts on the bid are correct. All alternate bids shall be bid separately and shall not be included in the primary bid. The complete work description line item pricing along with the Bid Proposal form must be completed and submitted.
- 1.2 Exact dimensions may not be provided in the work description. Any drawings given in specifications are approximated and should be verified by the bidder prior to submitting the proposal.
- 1.3 The price on the "Bid Proposal Form" should appear as a lump sum written in numbers as well as words. In the event that a discrepancy arises between the written and numerical presentation of the bid, the written presentation shall be used.
- 1.4 A specific time has been scheduled for a Pre-bid Inspection. The time and location is specified in the "Invitation for Bid". General Contractors shall make every effort to attend along with their subcontractors. At the Pre-bid Inspection, representatives from the Central Illinois Land Bank Authority (CILBA) and/or the local jurisdiction will review the Work Description including any alternate items. Site visits are not permitted prior to the Pre-bid Inspection. However, visits after the Pre-bid Inspection may be coordinated with CILBA and the local jurisdiction.

### 2.0 Determination of Winning Responsible Bid

A Qualified Contractor is defined as a contractor who has been designated by CILBA as a qualified contractor through CILBA's Contractor Request for Qualifications (RFQ) process. The Contractor RFQ can be found on CILBA's website ([www.cilba.org](http://www.cilba.org)) or can be requested via email ([mdavis@cilba.org](mailto:mdavis@cilba.org)).

- 2.1 Bids shall include all costs to complete the entire Scope of Work set forth in this Request for Proposals.
- 2.2 Interested bidders shall be able to demonstrate successful completion of at least three (3) similar projects in the last 12 months to be considered qualified to perform this work.
- 2.3 Contracts shall be awarded to the lowest responsible bidder, so long as the provided the bidder has complied with all bid specifications, instructions, and requirements.

### 3.0 Miscellaneous

- 3.1 If any requirement of this bid package is questionable or appears contradictory in nature, clarification should be requested in writing from CILBA using the contact information provided in the proposal. If any such clarification is requested, and CILBA regards the clarification as material in nature, CILBA may refuse to accept any bids and rebid the project.
- 3.2 Award of a contract as a result of this solicitation is contingent upon the availability of funds from which payment of this contract may be made. There shall be no legal liability on the part of CILBA or the property owner until funds are committed by a duly executed contract.
- 3.3 All work shall be performed in accordance with the "Work Description", applicable building safety codes, general specifications, laws, ordinances, rules and regulations of all agencies having legal jurisdiction over the performance of the work.
- 3.4 The contractor, by virtue of submitting a proposal, understands and agrees that this project is funded all or in part with public funds and much of the information submitted for this project is subject public disclosure.
- 3.5 All items included in the "Bid Proposal Form" are incorporated into the "Instructions to Bidders".
- 3.6 CILBA reserves the right to accept or reject any or all bids, waive any technicalities or informalities in the bidding, postpone the bid opening and to reject bids and/or award the Contract as determined to be in the best interest of CILBA.

Housing Rehab Project: #23-26  
Address: 1404 East Anthony Drive Urbana, IL

RETURN BY: November 1, 2023 at 12:00pm

RETURN TO: Office of the County Executive  
ATTN: Steve Summers  
1776 E Washington Street  
Urbana, Illinois 61802-4581

BID OPENING: November 1, 2023 at 1:00pm

BIDS OPENED: Office of the County Executive  
1776 E Washington Street  
Urbana, Illinois 61802-4581

All bids must be sealed, signed, and submitted to be honored for no less than twenty (20) days

1. Complete all work according to applicable state and local codes, the attached work description, general specifications (available by contacting CILBA), all manufacturer's specifications, and the Contract.
2. Permits must be obtained by the contractor from the relevant local jurisdiction's department prior to the commencement of work. If this is not done, all work will be suspended and fines levied.
3. Bid all work descriptions "as-is". Any major changes in the bid will be directed in written form. Bids lacking prices in any line item may be rejected.
4. Quantities, amounts, and measurements in the bid are provided for describing work only. It is each contractor's individual responsibility to examine the job and determine the amounts and quantities necessary to execute the work in compliance with the work description and general specifications. CILBA reserves the right to adjust quantities of work or to eliminate portions or entire work items at CILBA's discretion.
5. CILBA reserves the right to accept or reject all or portions of the bid(s) and to negotiate with the bidder selected to perform the work.
6. CILBA reserves the right to consider the bidders proposed commencement and completion dates as criteria in awarding all contracts. Alternate bids may be awarded but shall only be paid upon written authorization to perform the alternate work.
7. All questions pertaining to this bid, the work description, or general conditions or specifications should be directed to Mike Davis at [mdavis@cilba.org](mailto:mdavis@cilba.org).

8. General contractors must have Certificates of Insurance or equivalents from their subcontractors in their files. General contractors shall be liable for all workers, subcontractors, vendors, and deliverymen present on the work-site.
9. CILBA acts as “title company” and “technical advisor” on all rehabilitation projects. Lien Waivers and Affidavits shall include any and all payments made relative to the project and issued to workmen, vendors, subcontractors, suppliers and shall balance with the cost of the project and the amount paid.
10. No work is to be conducted until an executed Notice to Proceed is issued to the Contractor by CILBA.

## Generation Conditions

### 1. COMPLIANCE WITH LAWS

The selected bidder (“**Contractor**”) shall perform in compliance with all applicable federal, state and local laws, ordinances, statues, rules and regulations. The contractor shall be responsible for obtaining any and all necessary permits for a successful, legal rehabilitation.

### 2. CONFLICTS OF INTEREST

Bidders shall provide information regarding any real or potential conflict of interest, including but not limited to business or personal relationships with a CILBA Director or any parent, spouse, child, partner, or employer of a CILBA Director. Failure to reveal any potential conflict of interest at the time of Proposal may represent a breach of contract, subject to appropriate penalties.

### 3. SILENCE OF SPECIFICATIONS

The apparent silence of the specifications as to any detail or apparent omission from it as to a detailed description concerning any point shall be interpreted as meaning that only the best commercial material or practice shall prevail and that only items of the best materials or workmanship are to be used.

### 4. SUPERINTENDENCE

At the inception of the work, the Contractor shall notify CILBA’s Executive Director of the name of its job site agent. This agent shall be readily accessible during normal business hours at a minimum. The Contractor shall notify CILBA’s Executive Director of any change of the job site agent, immediately upon such change. The job site agent shall understand the plans and specifications and have experience managing rehabilitation projects. The job site agent shall have full authority to execute orders or directions of CILBA without reasonable delay, and to promptly supply such materials, equipment, tools, labor, and incidentals as may be required.

### 5. TIME

A. **Completion Date.** The Contractor shall complete work on or before the time indicated in the Scope of Work. The contract completion date or period may be extended only by written change order.

#### B. **Time Extensions**

i. Request for Time Extensions. All requests for extension of time to complete work shall be submitted by the Contractor in writing to CILBA’s Executive Director. The request shall specify the cause for the delay and the number of additional days sought to complete performance. The

request must be submitted within forty-eight (48) hours of the occurrence of the cause of the delay or shall be deemed waived.

In the event of delay due to causes beyond the reasonable control of the Contractor, a reasonable extension of time by the amount of time the Contractor is actually delayed thereby will be given by the way of a properly executed written Change Order. The extension of time granted shall be the exclusive relief provided, and no additional compensation of claim for damages will be paid or due.

ii. Causes Beyond the Reasonable Control of the Contractor. The following are grounds for extensions of time due to causes beyond the reasonable control of the Contractor:

1. Delay in CILBA's making the site available or in furnishing items to be furnished by CILBA that are necessary for Contractor to commence or continue work;
2. War, national conflicts, terrorist acts or priorities arising therefrom including restriction of the ability to procure critical materials;
3. Epidemics that affect the Contractors', sub-contractors' or material suppliers' ability to obtain construction labor or labor to produce materials;
4. Strikes or other labor disruptions extending in duration more than five calendar days;
5. Cataclysmic events;
6. Fires on the job site, adjacent to the work site, or involving the Contractors', sub-contractors' or material suppliers' property that materially affects the progress of the work.
7. Material delivery delays when the Contractor has exercised due diligence in securing critical materials.

iii. Liquidated Damages.

1. If the Contractor fails to perform as set forth in 2.6(a), Liquidated damages shall be charged at the rate of \$1,000.00 per calendar day for each day that the work is incomplete. CILBA will deduct these liquidated damages from any monies due or to become due to the Contractor from the CILBA.
2. By entering this agreement, the Contractor specifically acknowledges that it is impractical to calculate and prove actual delay costs for failure to complete the contract on time. The amount stated above accounts approximately for administration, engineering, inspection, and supervision costs of delay during

periods of delayed performance, as well as damages to the public for inability to use the public improvement.

## 6. METHOD OF PAYMENT

Payment will be made by CILBA after Contractor's complete performance of the Contract in accordance with all provisions thereof and upon subsequent receipt by CILBA of a properly executed invoice together with waivers of liens from all suppliers and subcontractors. Such invoice shall be accompanied by waivers of liens or the equivalent from supplier of work or materials stating that such work or materials have been paid for by the Contractor. Such invoice shall be paid by CILBA within sixty (60) days of its receipt, except for those sums allowed to be withheld pursuant to the Contract.

## 7. RIGHT TO WITHHOLD

In addition to the payments to be retained by CILBA under the other provisions of this contract, CILBA may withhold a sufficient amount of any payment otherwise due to the Contractor to cover the following:

- A. For claims arising in and from the performance of the work on the project under this Contract.
- B. For defective work not remedied.
- C. For failure of the Contractor to make proper payments to its subcontractors and suppliers.

CILBA shall disburse and shall have the right to act as agent for the Contractor in disbursing such funds as have been withheld pursuant to this paragraph to the party or parties who are entitled to payment therefrom (including CILBA). CILBA will render to the Contractor a proper accounting of all such funds disbursed on behalf of the Contractor.

## 8. CHANGE ORDERS AND EXTRA WORK

The CILBA Executive Director may, at any time or from time to time, order additions, deletions or revisions in the work; these will be authorized by Change Orders. Upon receipt of a Change Order, the Contractor shall proceed with the work involved. All such work shall be executed under the applicable conditions of the Contract. If any Change Order causes an increase or decrease in the Contract Price or an extension or shortening of the Contract time, the increase or decrease must be agreed to by both parties in writing.

## 9. MATERIALS & WORKMANSHIP

- i. Materials & Workmanship Excluded. The rehabilitation work shall be completed in all respects and all material used in the work and all work thereon shall be done in strict accordance with the specifications set forth herein. All work shall be done in a first-class and workmanlike manner to the satisfaction of CILBA and in accordance with the best practice, standards and standard specifications recognized in the field unless specifically provided for otherwise in the specifications or approved by CILBA in writing.
- ii. Final Inspection. When the work of rehabilitation is substantially completed, the Contractor shall notify the CILBA Executive Director that the work will be ready for final inspection on a definite date.
- iii. Inspections, Correction and Rejection. CILBA shall have the right to reject materials and workmanship which are defective or require correction. Rejected workmanship shall be satisfactorily corrected by Contractor and rejected materials shall be removed from the premises both without charge to CILBA. If the Contractor does not correct such defective work and remove rejected materials within a reasonable time, fixed by written notice, CILBA may remove them and charge the expenses to the Contractor.
- iv. Inspection after Completion. Should it be considered necessary or advisable by CILBA at any time before acceptance of the work to make an examination of work already completed by dissembling, removing or tearing out same, the Contractor shall on request promptly furnish all necessary facilities, labor and materials for that purpose and the costs thereof shall be charged to the Contractor if the work was covered prior to inspection by CILBA.
- v. No Waiver by Inspection or Payment. Neither the inspection of or payment for any work performed pursuant to any provision in the Contract shall relieve the Contractor of the responsibility for negligence or faulty materials or workmanship to the extent and within the period provided by law or this Contract, whichever is longer, and upon written notice, the Contractor shall remove any defects due therefrom and correct the same.

## 10. RISK OF LOSS; PROPERTY CONDITIONS

CILBA assumes no responsibility for the condition of existing structures and other property on the subject area nor for their continuance in the condition existing at the time of issuance of the Request for Proposals or thereafter. No adjustment of Contract Price or allowance for any change in conditions or unknown conditions shall be made.



## 11. INDEMNIFICATION AND HOLD HARMLESS

To the fullest extent allowed by law, Contractor shall indemnify and hold harmless CILBA against any and all damages to property or injuries to or death of any person or persons, including property and employees or agents of CILBA, and shall defend, indemnify and save harmless CILBA from any and all claims, demands, suits, actions or proceedings of any kind or nature, including Workers Compensation claims, and including the cost of defending same including costs and attorneys fees, of or by anyone whomsoever in any way resulting from or arising out of the operations of the Contractor or the Contractor's employees or subcontractors and acts or omissions of employees or agents of Contractor or subcontractors, unless caused solely by CILBA, its officers or employees. CILBA shall have the right to estimate the amount of such claims, demands, suits, actions or proceedings for damage or injuries and pay the same, and any amounts so paid shall be deducted from the money due the Contractor under this Contract, and the whole or so much of the money due or to become due the Contractor under this Contract, as may be considered necessary by CILBA, shall be retained by CILBA until such claims, demands, suits, actions, or proceedings shall have been settled or otherwise disposed of, and satisfactory evidence to that effect furnished to CILBA.

Insurance coverage specified in these General Conditions shall in no way lessen or limit the liability of Contractor under the terms of the contract. Contractor shall procure and maintain at the Contractor's own cost and expense, any additional kinds and amounts of insurance that, in the Contractor's own judgment, may be necessary for the Contractor's proper protection in the prosecution of the work.

## 12. TERMINATION FOR BREACH

In the event that any of the provisions of this Contract are violated by the Contractor or by any of its subcontractors, CILBA may serve written notice upon the Contractor and the surety, if applicable, of the intention to terminate such Contract, such notice to contain the reasons for such termination intention, and unless within five (5) calendar days after the serving of such notice upon the Contractor such violations shall cease and satisfactory arrangements for correction be made, the Contract shall upon expiration of five (5) calendar days cease and terminate.

In the event of any such termination, CILBA shall immediately serve notice thereof upon the surety and the Contractor, and the surety shall have the right to take over and perform the Contract; provided, however, that if the surety does not commence performance thereof within ten (10) calendar days from the date of the mailing to such surety notice of termination, CILBA may take over the work and prosecute the same to completion by contract with another or otherwise at the expense of the Contractor, and the Contractor and his surety shall be liable to CILBA for any excess cost occasioned CILBA thereby, and in such event, CILBA may take possession of and utilize in completing the work such materials and equipment as may be on the site of the work and necessary therefor.

### 13. INSURANCE REQUIRED

Contractor shall provide CILBA with a certificate of insurance showing that the Contractor has policies in effect for the entire duration of the Contract with coverage limits of not less than \$1,000,000 Comprehensive General Liability for accidents or injuries for each occurrence, and not less than \$2,000,000 in aggregate for the policy term; not less than \$500,000 Automobile for injuries, including accidental death, or damages caused by the contractor's vehicles on the site; and not less than the statutory amount and employer's liability of not less than \$500,000 per person Worker's Compensation coverage. The policies shall name the Central Illinois Land Bank Authority as "Additional Insured" for this Contract.

### 14. SUBCONTRACTORS

- A. No Contractual Relationship. Nothing contained in the contract documents shall create any contractual relationship between any subcontractor and CILBA.
- B. Notice. The Contractor shall notify CILBA in writing of the names of the subcontractors proposed for the principal parts of the Work, and shall not employ any subcontractor that CILBA objects to as incompetent or unfit, or that is determined to be legally ineligible to perform work under the Contract.
- C. Responsibility of Contractor. The Contractor agrees to be fully responsible to the City for the acts or omissions of each of its subcontractors and of anyone employed directly or indirectly by the Contractor or its subcontractors and this contract obligation shall be in addition to the liability imposed by law upon the Contractor. The Contractor agrees to bind every subcontractor (and every subcontractor of a subcontractor) and every subcontractor agrees to be bound by the terms of this Request for Proposals and the subsequent Contract as far as applicable to its work, unless specifically noted to the contrary in a subcontract approved in writing as adequate by CILBA.

### 15. SOLID WASTE AND HAZARDOUS MATERIALS.

The Contractor shall be responsible for proper disposal of all solid waste removed from the work site. The Contractor shall provide CILBA with appropriate documentation of its proper disposal upon request for any portion of the work resulting in the disposal of solid waste.

### 16. SANITARY FACILITIES

The Contractor shall furnish, install and maintain sufficient sanitary facilities for the workers, as the need arises.

### 17. VACATING OF BUILDINGS

If the rehabilitation work requires vacated structures and the Contractor finds that any structures are not vacated, the Contractor shall immediately notify CILBA's Executive Director and shall not

begin rehabilitation operations on such properties until so authorized by CILBA, and the Contractor's responsibility for such buildings will not begin until such order from CILBA has been sent to the Contractor. In case such occupancy is of a prolonged nature which actually interferes or is likely to interfere with the Contractor's operations so as to materially increase the Contractor's costs or require additional time, both parties shall agree to a Change Order or agree to otherwise terminate the Contract.

#### 18. ACCIDENT PREVENTION; CONTRACTOR

The Contractor shall exercise all reasonable precaution at all times for the protection of all persons and property and shall be responsible for all damages to persons or property, either on or off the work site, which occur as a result of Contractor's fault or negligence in connection with the performance of the work. Final payment or inspection shall not be deemed a waiver of Contractor's responsibility. The safety provisions of applicable laws and building and construction codes shall be observed. Machinery, equipment and all hazards shall be guarded in accordance with the safety provisions of the "Manual of Accident Prevention in Construction" published by the Associated General Contractors of America, Inc., to the extent that such provisions are not in conflict with applicable local laws.

#### 19. DISPUTES

All disputes of claims between the Contractor and CILBA shall come to the attention of CILBA's Executive Director for resolution, including all matters relating to the execution and satisfactory completion of the Work.

#### 20. ATTORNEYS FEES

The Contractor shall be responsible for all costs incurred by CILBA to enforce any provision of this contract and/or to remedy any Contractor default or breach of contract, including all court costs and reasonable attorneys fees.

#### 21. EMERGENCY SITUATIONS

In an emergency affecting the safety of life or property, on or adjoining the site, the Contractor shall act to prevent such threatened loss or injury.

#### 22. AVOIDANCE OF DAMAGE TO PROPERTY OF OTHERS

The Contractor shall avoid damaging sidewalks, streets, curbs, pavements, utilities, structures or any other property. The Contractor shall repair, at the Contractor's own expense and in a manner satisfactory to CILBA and the local jurisdiction any damage thereto caused by the Contractor's operations. The Contractor shall be responsible for locating all utilities on the property and arranging for their disconnection in accordance with all laws and ordinances and utility regulations incurred. Any costs shall be paid by the Contractor.

### 23. ASSIGNMENT OF CONTRACT

The Contractor shall not assign this Contract or any part hereof without the written consent of the CILBA's Executive Director. No assignment of this Contract shall be valid unless it shall contain a provision that the funds to be paid to the assignee under the assignment are subject to a prior lien for services rendered or materials supplied for the performance of the work called for in said Contract in favor of all persons, firms, or corporations rendering such services or supplying such materials.

### 24. PUBLIC ADVERTISING

The Contractor is specifically denied the right of using in any form or medium the name of the Central Illinois Land Bank Authority for public advertising unless express permission is granted by the Executive Director and Board of Directors of CILBA.

### 25. RECORD AND AUDITS

The Contractor shall maintain accounts and records, including personnel, property and financial records, adequate to identify and account for all costs pertaining to the Contract and such other records as may be deemed necessary by CILBA to assure proper accounting for all project funds. These records will be made available for audit purposes to CILBA or any authorized representative and will be retained for three (3) years after the expiration of this Contract unless permission to destroy them is granted by CILBA.

### 26. USE OF PREMISES

The Contractor shall confine its equipment, storage of materials, and rehabilitation operations to the limits prescribed by local ordinance or relevant permits, or as may be directed by CILBA's Executive Director and shall not unreasonably encumber the premises with its salvaged materials.

### 27. BID-RIGGING, BID-ROTATING PROHIBITED

The Contractor certifies, in accordance with Section 33E-11 of the Illinois Criminal Code, that the Contractor is not barred from bidding on any contract with the City as the result of a violation of 720 ILCS 5/33E-3, Bid-Rigging, or 720 ILCS 5/33E-4, Bid Rotating, as amended.

### 28. PREFERENCE TO VETERANS ACT

The Contractor shall comply with the Veterans Preference Act, 330 ILCS 55/1, as amended, in the employment and appointment to fill positions in the construction, addition to, or alteration of any public works.

### 29. EMPLOYMENT OF ILLINOIS WORKERS OF PUBLIC WORKS ACT

If at the time this contract is executed, or if during the term of this contract, there is a period of excessive unemployment in Illinois, defined in the Employment of Illinois Workers on Public Works Act, 30 ILCS 570/0.01, as “any month immediately following 2 consecutive months of unemployment in the State of Illinois that has exceeded 5%”, the Contractor agrees to employ Illinois laborers. An “Illinois laborer” is defined as “any person who has resided in Illinois for at least 30 days and intends to become or remain an Illinois resident.” 30 ILCS 570/1(i).

### 30. TRAFFIC CONTROL

The Contractor shall be responsible for providing adequate safeguards to ensure traffic control and safety at the job site and to meet or exceed minimum standards required by local, State and federal requirements for traffic control. Contractor shall use professional judgement to assess the traffic safety and control measures required by this job and shall describe measures the Contractor will take to ensure traffic safety and control for this job.

### 31. DELINQUENT TAXES & INDEBTEDNESS

Pursuant to 65 ILCS 5/11-42.1-1, Contractor shall not be or become delinquent in the payment of any tax administered by the Illinois Department of Revenue during the Term of the Contract. Additionally, Contractors and Subcontractors indebted to the local jurisdiction, must settle all debts prior to awarding a contract. Before awarding a Contract the Central Illinois Land Bank Authority must obtain, under oath from the individuals or entities that no such taxes or debt are outstanding or delinquent.

### 32. NON-DISCRIMINATION

Contractor shall not discriminate against any employee or applicant for employment because of race, creed, color, religion, sex, ancestry, and national origin, place of birth, marital status or age.

### 33. SEXUAL HARASSMENT

Contractor is required to have a sexual harassment policy as part of its company policies. If your policy complies with the elements contained in the sexual harassment guidelines, please submit a copy. If you need to establish a policy, the Contractor have sixty (60) days from the date you submit a bid to establish such policy.

### 34. SCHEDULES

Contractor shall submit a clear schedule of times for initiation and completion for each segment of the project and shall notify CILBA if deviations occur. Contractor shall submit a schedule of values identifying costs for each segment of the project.

### 35. PROTECTION/REPAIRS/REPLACEMENT

Contractor shall not damage any building, grounds, pavement or other surfaces or utilities during the construction. All damages shall be repaired in a manner acceptable to CILBA and the local jurisdiction at no cost to CILBA or the local jurisdiction. Any removal of structures/equipment, relocation of existing equipment or utilities, installation of devices or other temporary measures to aid in the construction shall be repaired and/or replaced by the Contractor in a manner acceptable to CILBA and the local jurisdiction at no additional cost to CILBA and the local jurisdiction.

### 36. SITE COMPLETION

Contractor shall be responsible for returning the site to CILBA in a condition acceptable to the local jurisdiction. This includes but is not limited to; removal of all trash and construction debris, resetting any objects moved to aid in construction and repair/replacement of any and all damages.

[Remainder left blank]

## SCOPE OF WORK

Address: 1404 East Anthony Drive Urbana, IL

# of Stories: one

This work write-up is in accordance with the Standards and guidelines. Contractor shall abide by the following: 2015 International Building Codes, 2014 Illinois Plumbing Codes, 2015 Illinois Mechanical Codes, Zoning and 2017 Electrical Codes, 2018 IECC code chapter R4, and all current adopted city codes. If there are questions regarding code, it is the contractor's responsibility to seek out answers with the authority having jurisdiction.

The contractor is required to obtain all permits necessary to complete the project. No work is to be started until the permit for that area of work has been issued and displayed at the property. The contractor will be liable for any fines incurred for not obtaining the required permits.

Signed change orders by CILBA representative are required prior to modifications to the original contract scope or price. No changes to contract price will be paid without a written change order signed by CILBA representative.

Where applicable, lead-based paint will be handled using RRP standards and guidelines. All work shall be completed with craftsmanship equivalent to industry standards. The quality of material shall be of standard grade and remain cost-effective for the project. All mechanical and Plumbing fixtures per the outlined scope must be replaced with Energy Efficient products.

The contractor is responsible for all labor associated with demolition and disposal fees. The contractor is required to maintain the exterior of the property during the time of construction in an orderly manner that will not create a nuisance. The contractor will be liable for any fines occurred for not maintaining the property.

All measurements, quantities, size, design, etc noted in the scope of work are for the contractor's convenience and shall be verified by the contractor prior to contract acceptance. No guarantee or warranty of accuracy is represented by CILBA. No claim for additional funds due to discrepancies in the measures or quantities shall be honored if not submitted at the time of the initial proposal.

The contractor shall remedy any defect due to faulty material or workmanship and pay for all damage to other work resulting therefore, which appear within one year from the completion of the project.

#### **A. Roof:**

1. Replace roof at above mention property. – Perform complete tear off of all existing layers of roofing materials down to the sheathing. Inspect existing roof sheathing and rafters, identify deteriorating sheathing and or rafters and seek Project Manager’s approval to remove them. Replacement sheathing should match existing thickness. Install ice and water barrier, drip edge, flashing, 225 LB felt (minimum)/adhesive roof underlayment, proper venting, and architectural shingles, all per code and manufacturer specifications. Color to be approved by the homeowner and CILBA. **Options limited to GAF HDZ Shingles - Charcoal, Pewter, Weathered Wood, and Mission Brown.**
2. Replace aluminum fascia.
3. Install all new seem less gutters all around the house. **Note homeowner request to save and re install the existing gutter guards.**
4. Install all aluminum soffits around the house.

#### **Sheathing**

Please provide a written cost to replace sheathing per piece if need.  
Provide pictures of affected areas of any repair before and after has been fixed.

Note: visible damage to the valley please provide an estimate to repair the valley with a not to exceed amount.

#### **Siding**

Replace siding around the property with a vinyl siding color to be chosen by homeowner from the following color only, royal **vinyl d4 – white, sand, Harvard slate, soft maple.**

#### **Site organization**

Job site cleanliness is a must. job site to remain organized and maintained in professional manner.



**BID REQUEST FORM**

Housing Rehab Project #23-26  
Address: 21404 East Anthony Drive Urbana, IL

DATE RFP RELEASED: October 23, 2023

DATE BIDS DUE: November 1, 2023

Project: #23-26, 1404 East Anthony Drive Urbana, IL

The following is hereby submitted as per your request. This bid covers all work and/or specified in the bid documents received for this job.

The undersigned, having become thoroughly familiar with the terms and conditions of the proposed Contract Documents and with local conditions affecting the performance and costs of the Work at the place where the work is to be completed, and having fully inspected the site in all particulars, hereby proposes and agrees to full perform the work within the time stated and in strict accordance with the proposed Contract Document, including furnishing of any construct, and complete said Work in accordance with the Contract Documents, for the sum of money:

All labor, materials, services, and equipment necessary for the completion of the Work shown on the Drawings and in the Specifications: Contractor and/or Subcontractor is responsible for all required permits.

Total bid: \_\_\_\_\_ Dollars (\$\_\_\_\_\_)

If awarded the Contract, the Bidder agrees to have on file with the Agency all required documents for verification of licensing and insurance. Completion of the project will require \_\_\_\_\_ calendar days. This proposal is valid for a period of 60 days.

Contractor information:

Name: \_\_\_\_\_  
Address: \_\_\_\_\_  
City, St, Zip: \_\_\_\_\_  
Phone: \_\_\_\_\_  
Fed. Tax ID: \_\_\_\_\_

Contractor Signature: \_\_\_\_\_ Date: \_\_\_\_\_

**ATTACHMENT A**

**Hover Report**

See Next Page

**NOTE:** Address listed on attached hover report is the same address as 1404 E Anthony.



[VIEW 3D MODEL](#)

Areas	Siding	Other
Facades	1500 ft <sup>2</sup>	200 ft <sup>2</sup>
Openings	357 ft <sup>2</sup>	-
Trims*	29 ft <sup>2</sup>	-
Unknown (no photos)*	-	-
<b>Total</b>	<b>1886 ft<sup>2</sup></b>	<b>200 ft<sup>2</sup></b>

\*Any trim or unknown material that touches siding is included in the 'Siding' column. If it does not touch siding, then it's included in the 'Other' column.

Openings	Siding	Other
Quantity	18	0
Tops Length	67'	-
Sills Length	47' 8"	3' 4"
Sides Length	119'	1' 6"
<b>Total Perimeter</b>	<b>233' 8"</b>	<b>4' 10"</b>

Corners	Siding	Other
Inside Qty	4	0
Inside Length	16' 11"	-
Outside Qty	6	0
Outside Length	49'	-

Accessories	Siding	Other
Shutter Qty	6	0
Shutter Area	24 ft <sup>2</sup>	0 ft <sup>2</sup>
Vents Qty	0	6
Vents Area	0 ft <sup>2</sup>	4 ft <sup>2</sup>

Trim	Siding	Other
Level Starter	239' 1"	168' 11"
Sloped Trim	-	19' 11"
Vertical Trim	7"	12' 4"

Roofline	Length	Avg. Depth	Soffit Area
Eaves Fascia	231' 9"	-	-
Level Frieze Board	221' 3"	2' 2"	461 ft <sup>2</sup>
Rakes Fascia	52' 8"	-	-
Sloped Frieze Board	41' 3"	-	0 ft <sup>2</sup>

**SIDING WASTE TOTALS**

Siding & Trim Only*	Area	Squares
Zero Waste	1529 ft <sup>2</sup>	15½
+10%	1684 ft <sup>2</sup>	17
+18%	1803 ft <sup>2</sup>	18¼

+ Openings < 20ft <sup>2</sup>	Area	Squares
Zero Waste	1736 ft <sup>2</sup>	17½
+10%	1911 ft <sup>2</sup>	19¼
+18%	2048 ft <sup>2</sup>	20½

+ Openings < 33ft <sup>2</sup>	Area	Squares
Zero Waste	1776 ft <sup>2</sup>	18
+10%	1955 ft <sup>2</sup>	19¾
+18%	2095 ft <sup>2</sup>	21

\*The first three rows of the Siding Waste Factor table are calculated using the total ft<sup>2</sup> of siding facades, ft<sup>2</sup> of trim touching siding, and ft<sup>2</sup> of unknowns touching siding.

Roof	Area	Total	Length
Roof Facets	2586 ft <sup>2</sup>	6	-
Ridges / Hips	-	7	124' 9"
Valleys	-	2	30' 8"
Rakes	-	6	52' 8"
Eaves	-	6	231' 9"
Flashing	-	9	50' 2"
Step Flashing	-	0	-
Drip Edge/Perimeter	-	-	284' 5"

Roof Pitch*	Area	Percentage
4 / 12	2586 ft <sup>2</sup>	100%

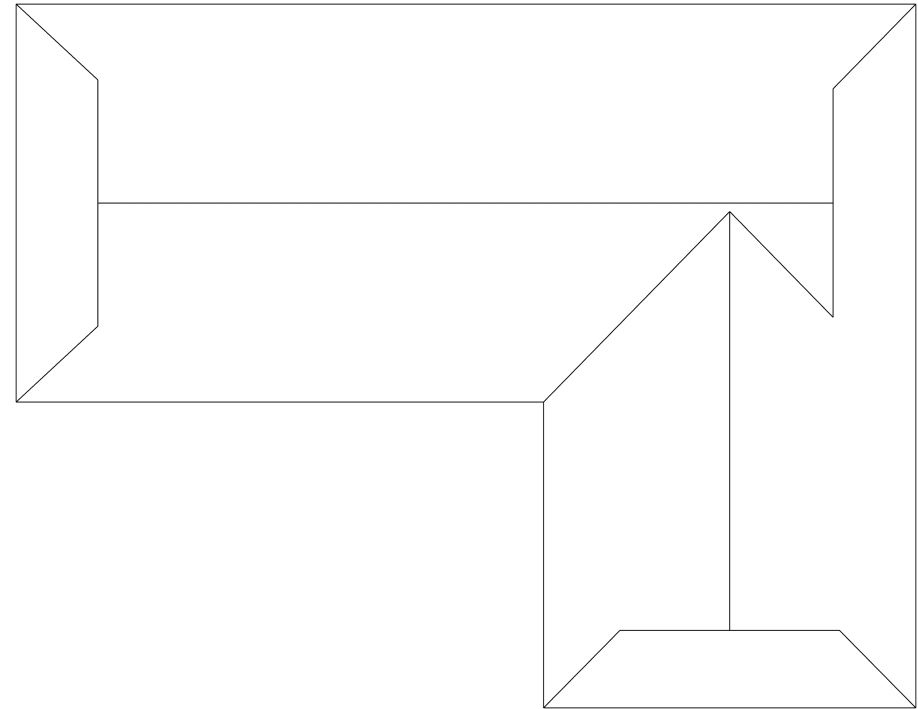

**Example Waste Factor Calculations**

	Zero Waste	+5%	+10%	+15%	+20%
<b>Area</b>	2586 ft <sup>2</sup>	2715 ft <sup>2</sup>	2845 ft <sup>2</sup>	2974 ft <sup>2</sup>	3103 ft <sup>2</sup>
<b>Squares</b>	26	27 <sup>1</sup> / <sub>3</sub>	28 <sup>2</sup> / <sub>3</sub>	30	31 <sup>1</sup> / <sub>3</sub>

The table above provides the total roof area of a given property using waste percentages as noted. Please consider that area values and specific waste factors can be influenced by the size and complexity of the property, captured image quality, specific roofing techniques, and your own level of expertise. Additional square footage for Hip, Ridge, and Starter shingles are not included in this waste factor and will require additional materials. This table is only intended to make common waste calculations easier and should not be interpreted as recommendations.

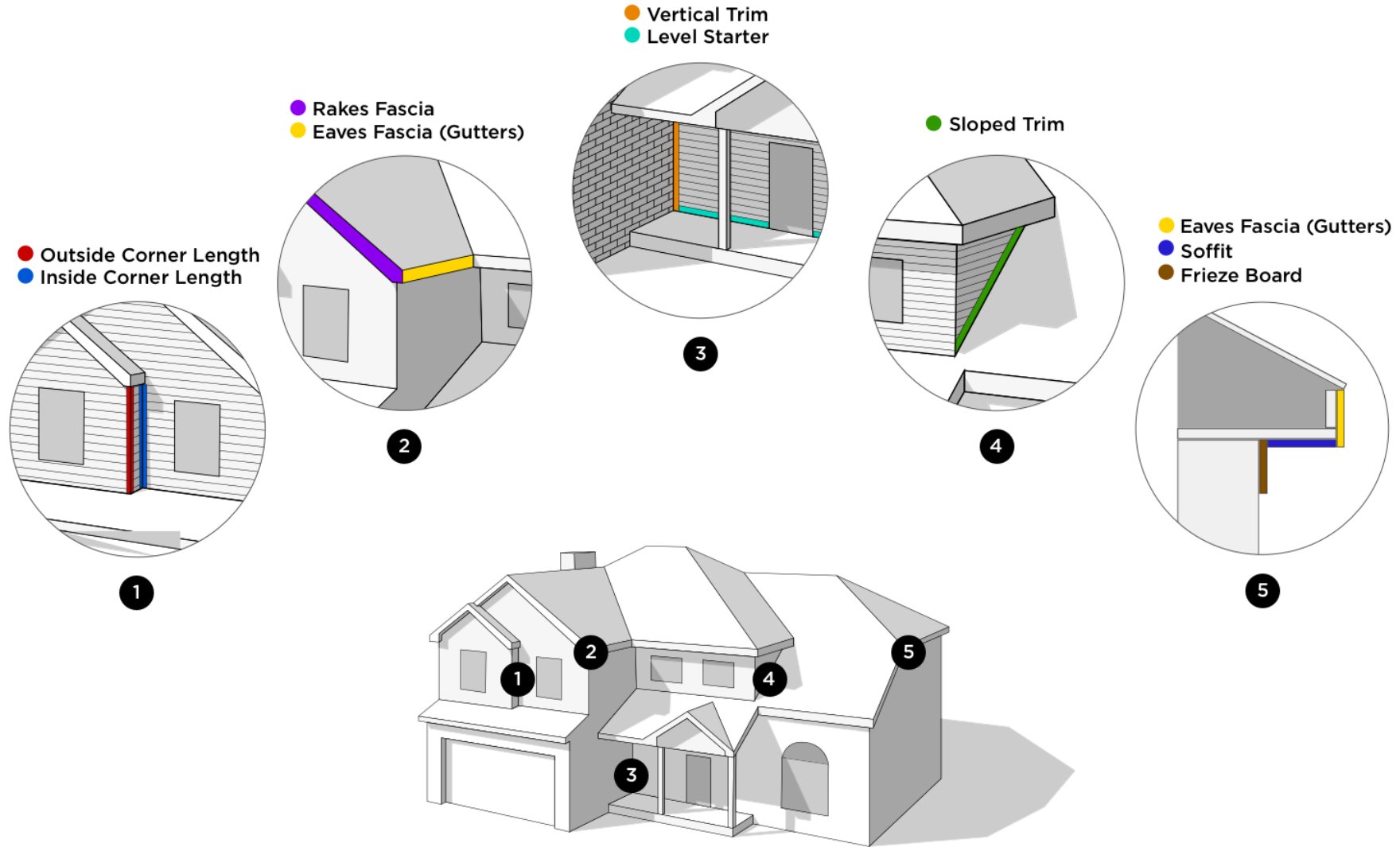

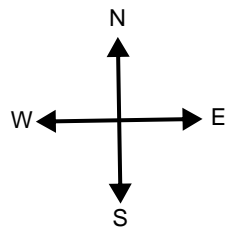

Number of Stories: 1  
 Footprint Perimeter: 217'  
 Footprint Area: 2034 ft<sup>2</sup>

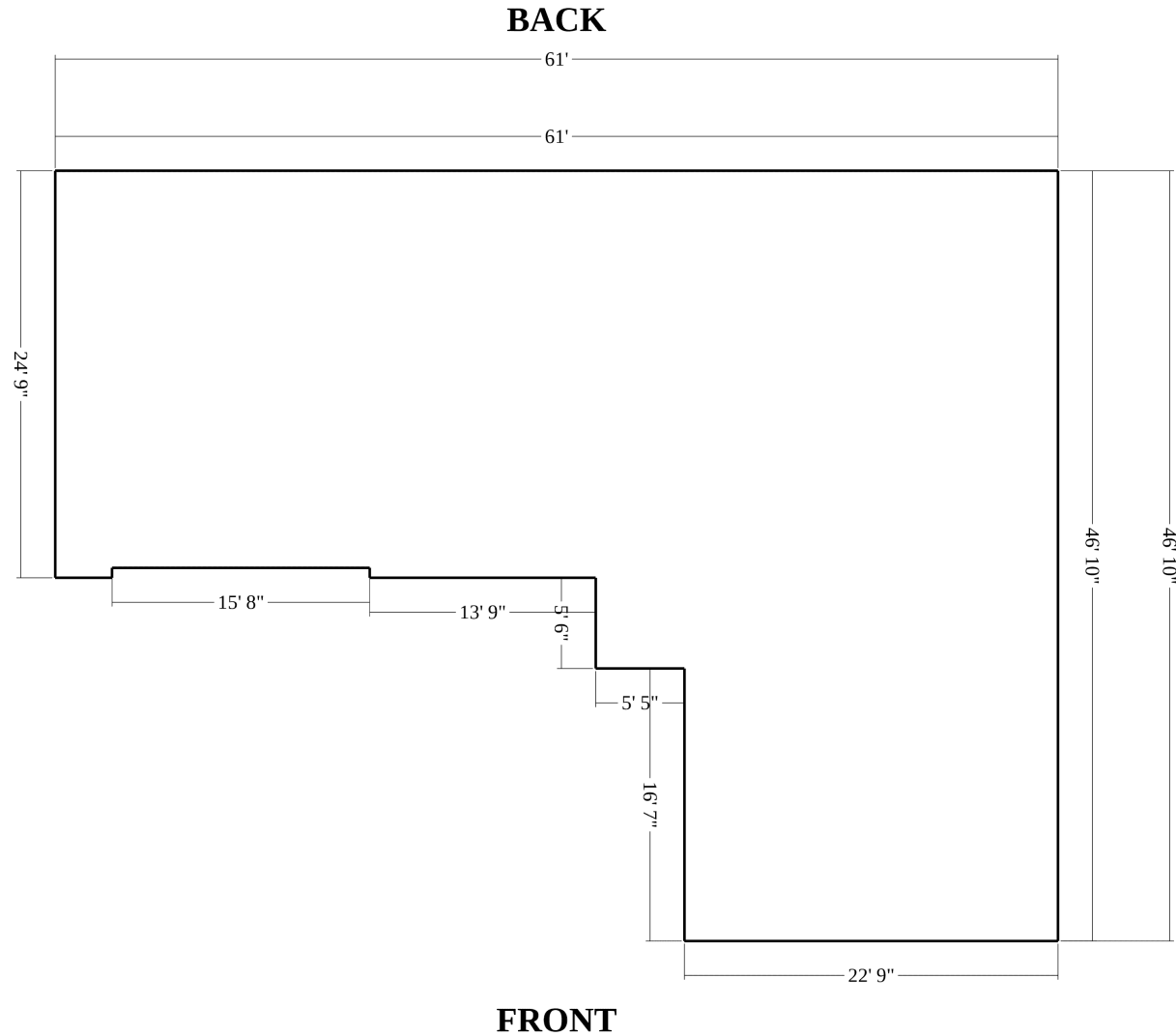

Siding Per Elevation

FRONT			RIGHT			LEFT			BACK		
SI-1	-	166 ft <sup>2</sup>	SI-5	-	355 ft <sup>2</sup>	SI-9	-	8 ft <sup>2</sup>	SI-7	-	24 ft <sup>2</sup>
SI-2	-	26 ft <sup>2</sup>	SI-6	-	13 ft <sup>2</sup>	SI-10	-	107 ft <sup>2</sup>	SI-8	-	439 ft <sup>2</sup>
SI-3	-	145 ft <sup>2</sup>				SI-11	-	16 ft <sup>2</sup>			
SI-4	-	12 ft <sup>2</sup>				SI-12	-	189 ft <sup>2</sup>			
<b>349 ft<sup>2</sup></b>			<b>368 ft<sup>2</sup></b>			<b>320 ft<sup>2</sup></b>			<b>463 ft<sup>2</sup></b>		

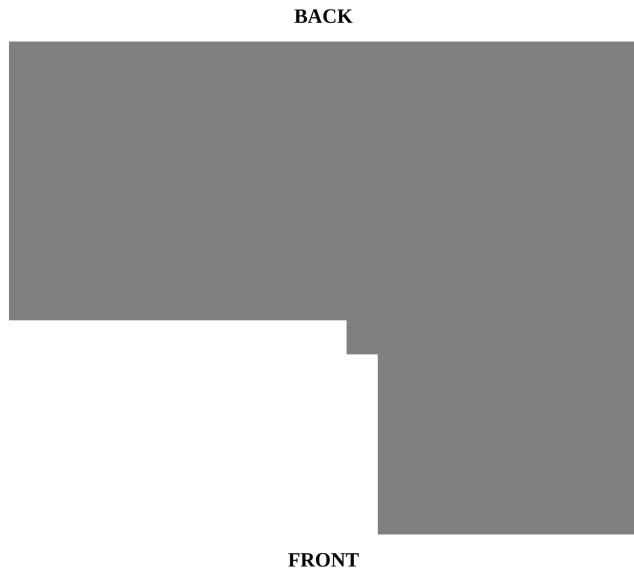

Number of Stories: 1

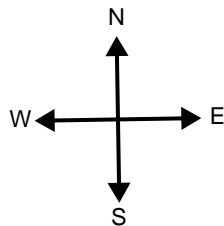



Soffit Summary

Depth	Type	Count	Total Length	Total Area
18" - 24"	eaves	5	199' 6"	398 ft <sup>2</sup>
24" - 48"	eaves	2	27' 11"	63 ft <sup>2</sup>
<b>Totals</b>			<b>227' 5"</b>	<b>461 ft<sup>2</sup></b>

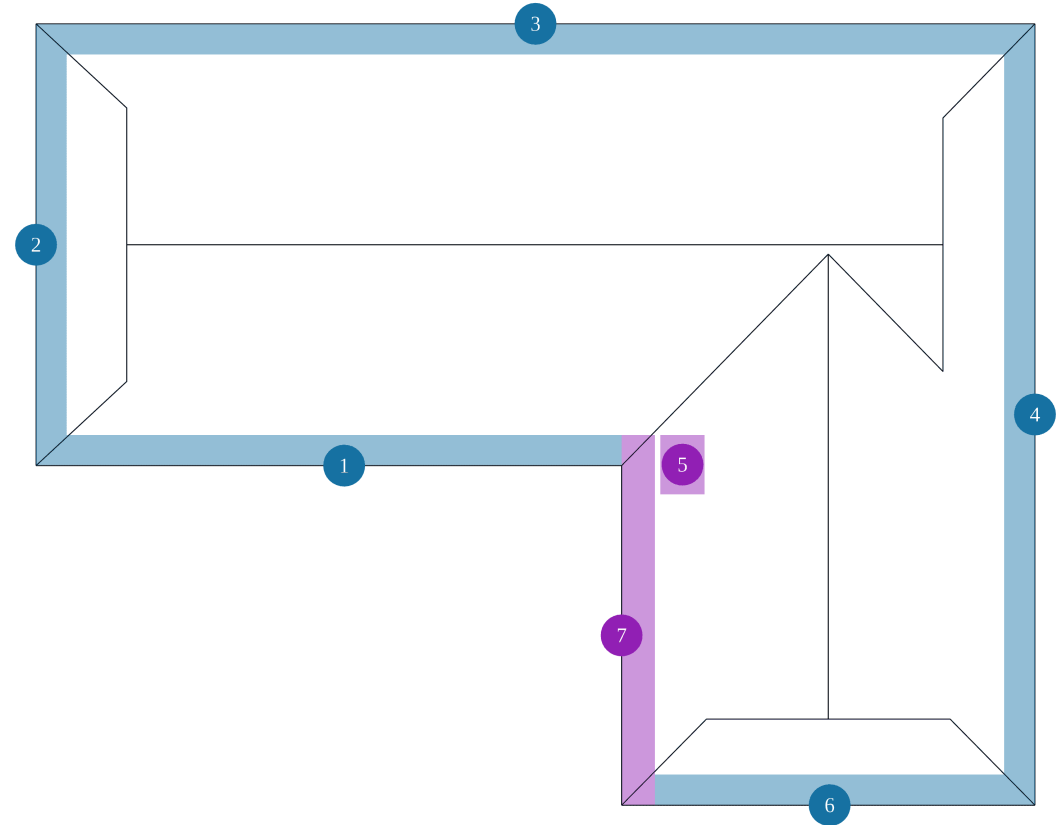

Soffit Breakdown

- 
- 
- 
- 
- 
- 
- 

num	Type	Depth	Length	Area	Pitch
1	eave	24"	36' 1"	72 ft <sup>2</sup>	4 / 12
2	eave	24"	28' 9"	57 ft <sup>2</sup>	4 / 12
3	eave	24"	61'	122 ft <sup>2</sup>	4 / 12
4	eave	24"	50' 10"	101 ft <sup>2</sup>	4 / 12
5	eave	35"	3' 10"	11 ft <sup>2</sup>	4 / 12
6	eave	24"	22' 9"	45 ft <sup>2</sup>	4 / 12
7	eave	26"	24' 1"	52 ft <sup>2</sup>	4 / 12

Ø Feature is too small to label on the plan diagram

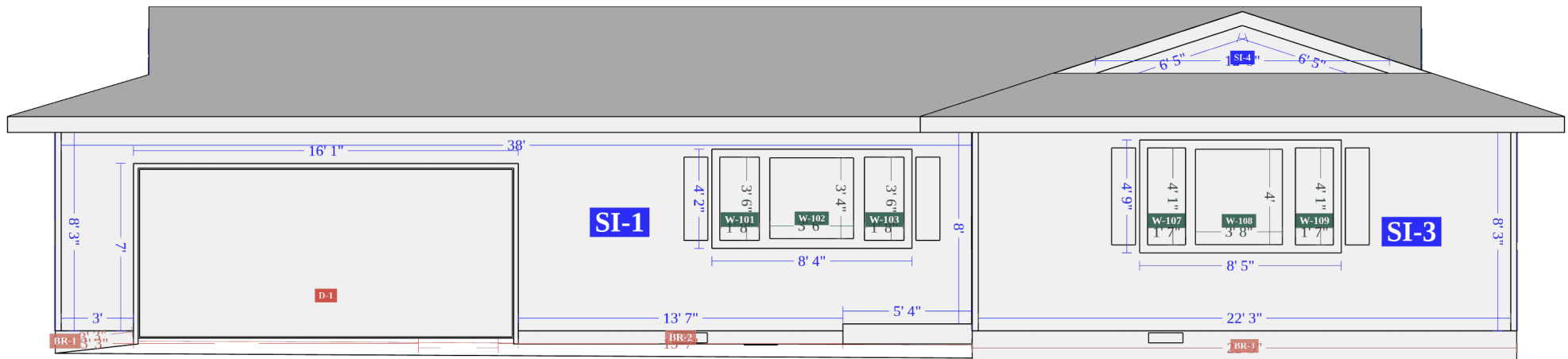
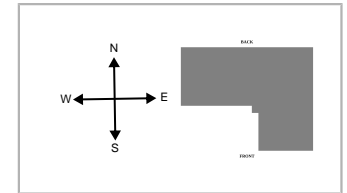

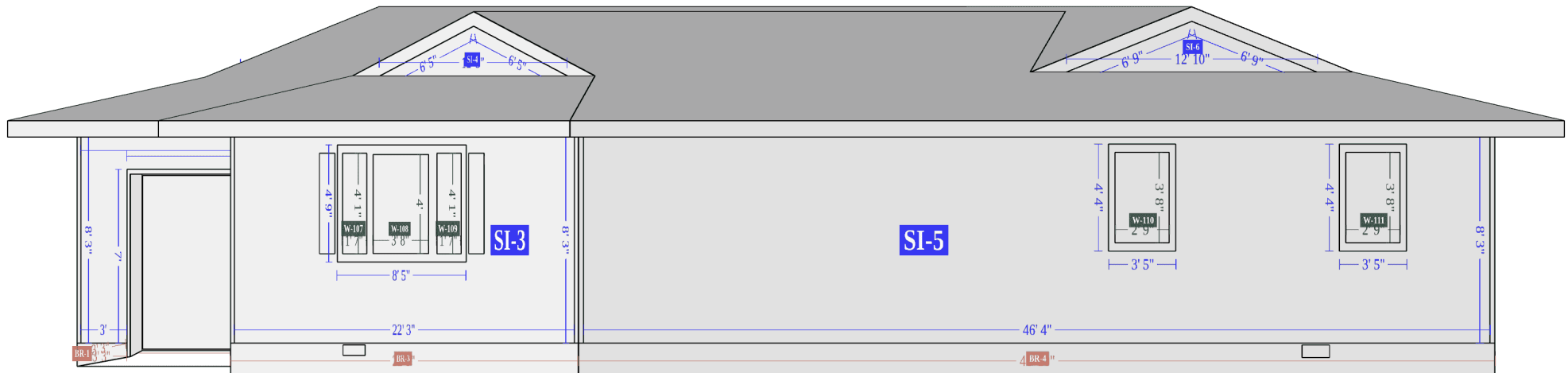
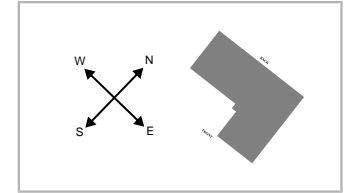

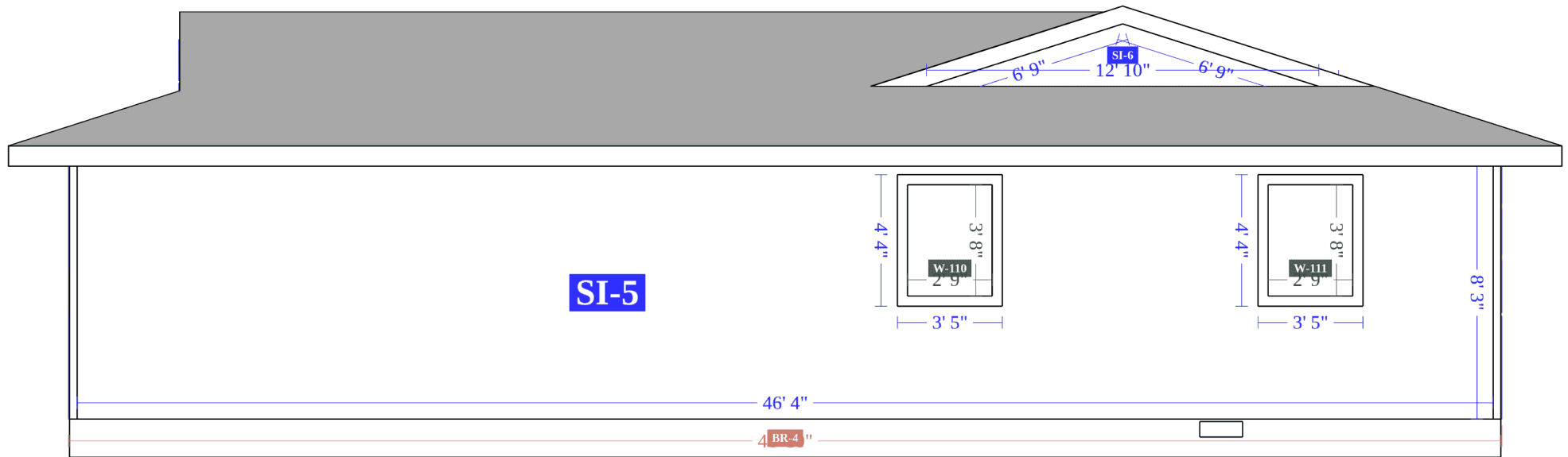
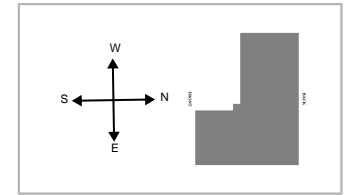

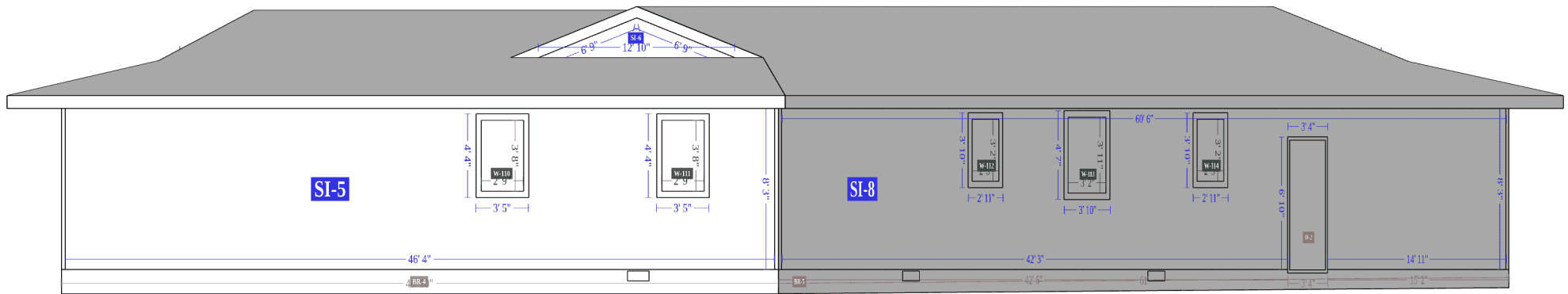
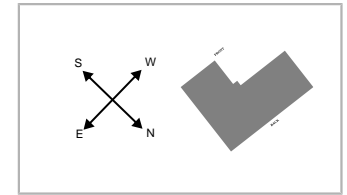

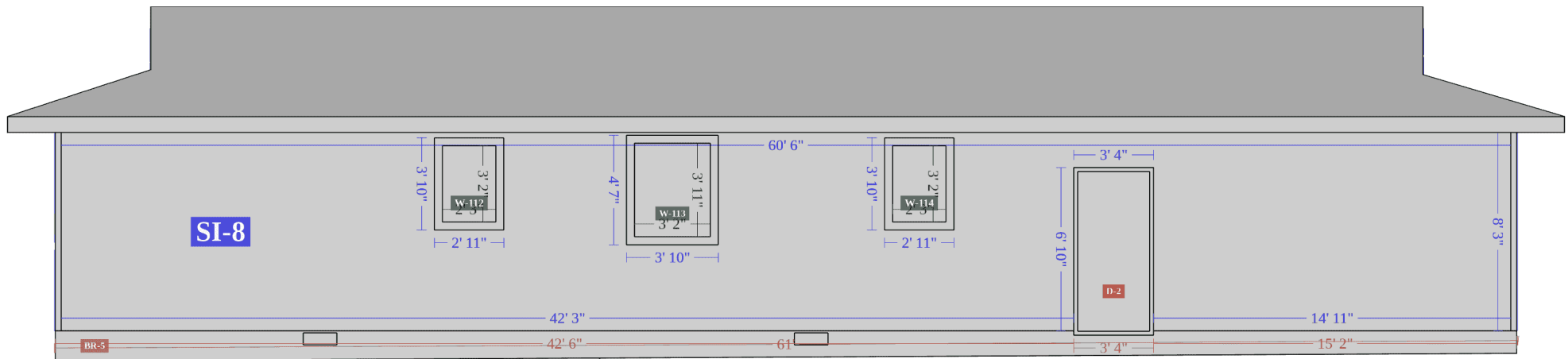
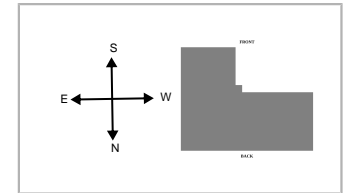

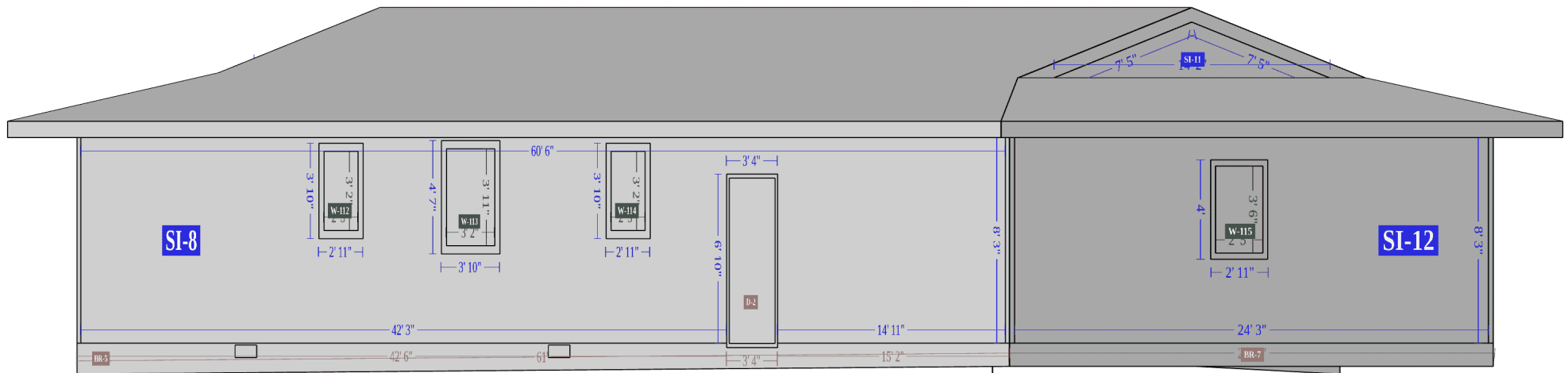
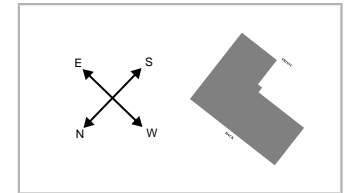



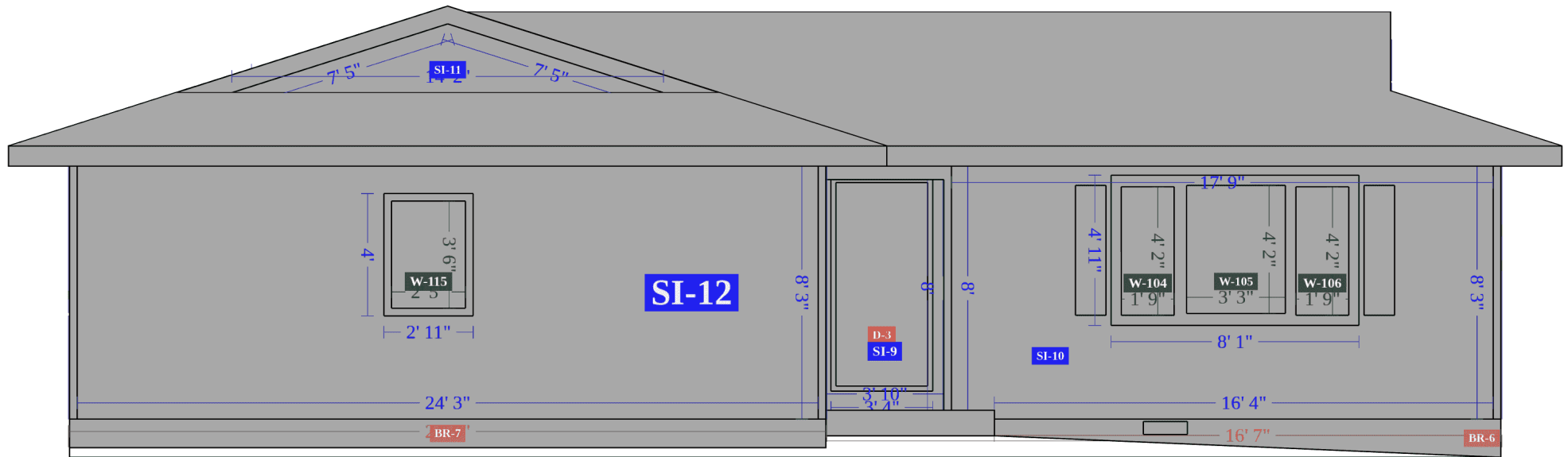
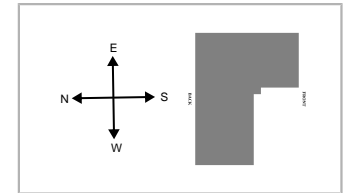

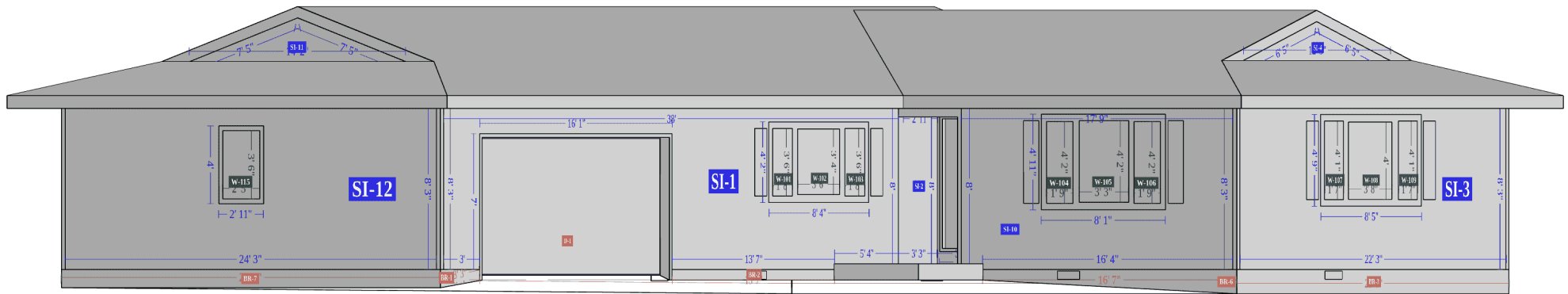
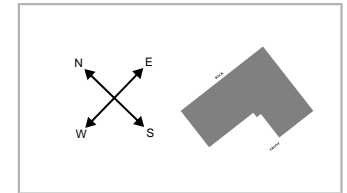

Siding

Facade	Area	Inside Corners	Outside Corners	Openings	Shutters	Vents
SI-1	166 ft <sup>2</sup>	-	1	4	2	-
SI-2	26 ft <sup>2</sup>	2	1	-	-	-
SI-3	145 ft <sup>2</sup>	-	2	3	2	-
SI-4	12 ft <sup>2</sup>	-	-	-	-	-
SI-5	355 ft <sup>2</sup>	-	2	2	-	-
SI-6	13 ft <sup>2</sup>	-	-	-	-	-
SI-7	24 ft <sup>2</sup>	2	1	-	-	-
SI-8	439 ft <sup>2</sup>	-	2	4	-	-
SI-9	8 ft <sup>2</sup>	2	-	1	-	-
SI-10	107 ft <sup>2</sup>	-	2	3	2	-
SI-11	16 ft <sup>2</sup>	-	-	-	-	-
SI-12	189 ft <sup>2</sup>	-	2	1	-	-
Total	1500 ft <sup>2</sup>	6	13	18	6	0

**Brick**

Facade	Area	Openings	Shutters	Vents
BR-1	2 ft <sup>2</sup>	-	-	-
BR-2	7 ft <sup>2</sup>	-	-	1
BR-3	28 ft <sup>2</sup>	-	-	1
BR-4	59 ft <sup>2</sup>	-	-	1
BR-5	66 ft <sup>2</sup>	-	-	2
BR-6	15 ft <sup>2</sup>	-	-	1
BR-7	23 ft <sup>2</sup>	-	-	-
Total	200 ft <sup>2</sup>	0	0	6

Facades

Facade	Area	Trim			Corners		Roofline		Openings		
		Level Starter	Sloped	Vertical	Inside	Outside	Level Frieze Board	Sloped Frieze Board	Tops	Sills	Sides
SI-1	166 ft <sup>2</sup>	21' 11"	-	3"	-	8' 3"	38'	-	24' 5"	8' 4"	22' 3"
SI-2	26 ft <sup>2</sup>	3' 3"	-	-	8' 5"	7' 7"	2' 11"	-	-	-	-
SI-3	145 ft <sup>2</sup>	22' 3"	-	-	-	16' 7"	22' 3"	-	8' 5"	8' 5"	9' 5"
SI-4	12 ft <sup>2</sup>	12' 3"	-	-	-	-	-	12' 11"	-	-	-
SI-5	355 ft <sup>2</sup>	46' 4"	-	-	-	16' 7"	46' 4"	-	6' 10"	6' 10"	17' 3"
SI-6	13 ft <sup>2</sup>	12' 10"	-	-	-	-	-	13' 6"	-	-	-
SI-7	24 ft <sup>2</sup>	3'	-	-	8' 5"	7' 7"	2' 11"	-	-	-	-
SI-8	439 ft <sup>2</sup>	57' 2"	-	-	-	16' 7"	60' 6"	-	12' 11"	9' 7"	38' 2"
SI-9	8 ft <sup>2</sup>	3' 10"	-	-	16'	-	3' 10"	-	3' 4"	3' 4"	14'
SI-10	107 ft <sup>2</sup>	17' 9"	-	3"	-	15' 10"	17' 9"	-	8' 1"	8' 1"	9' 10"
SI-11	16 ft <sup>2</sup>	14' 2"	-	-	-	-	-	14' 10"	-	-	-
SI-12	189 ft <sup>2</sup>	24' 3"	-	-	-	16' 7"	24' 3"	-	2' 11"	2' 11"	8'
Total*	1500 ft <sup>2</sup>	239' 1"	-	7"	16' 11"	49'	218' 9"	41' 3"	67'	47' 8"	119'

\*Totals de-duplicate any line segments that are shared between multiple facades, and as a result may not represent a total summation of the corresponding column.

**Example Waste Factor Calculations**

**SIDING & TRIM ONLY**

	Zero Waste	+10%	+18%
SI-1	166 ft <sup>2</sup>	183 ft <sup>2</sup>	196 ft <sup>2</sup>
SI-2	26 ft <sup>2</sup>	29 ft <sup>2</sup>	31 ft <sup>2</sup>
SI-3	145 ft <sup>2</sup>	160 ft <sup>2</sup>	171 ft <sup>2</sup>
SI-4	12 ft <sup>2</sup>	13 ft <sup>2</sup>	14 ft <sup>2</sup>
SI-5	355 ft <sup>2</sup>	391 ft <sup>2</sup>	419 ft <sup>2</sup>
SI-6	13 ft <sup>2</sup>	14 ft <sup>2</sup>	15 ft <sup>2</sup>
SI-7	24 ft <sup>2</sup>	26 ft <sup>2</sup>	28 ft <sup>2</sup>
SI-8	439 ft <sup>2</sup>	483 ft <sup>2</sup>	518 ft <sup>2</sup>
SI-9	8 ft <sup>2</sup>	9 ft <sup>2</sup>	9 ft <sup>2</sup>
SI-10	107 ft <sup>2</sup>	118 ft <sup>2</sup>	126 ft <sup>2</sup>
SI-11	16 ft <sup>2</sup>	18 ft <sup>2</sup>	19 ft <sup>2</sup>
SI-12	189 ft <sup>2</sup>	208 ft <sup>2</sup>	223 ft <sup>2</sup>
Trims	29 ft <sup>2</sup>	32 ft <sup>2</sup>	34 ft <sup>2</sup>
<b>Total</b>	<b>1529 ft<sup>2</sup></b>	<b>1684 ft<sup>2</sup></b>	<b>1803 ft<sup>2</sup></b>

**+ OPENINGS < 20FT<sup>2</sup>**

	Zero Waste	+10%	+18%
	190 ft <sup>2</sup>	209 ft <sup>2</sup>	224 ft <sup>2</sup>
	26 ft <sup>2</sup>	29 ft <sup>2</sup>	31 ft <sup>2</sup>
	171 ft <sup>2</sup>	188 ft <sup>2</sup>	202 ft <sup>2</sup>
	12 ft <sup>2</sup>	13 ft <sup>2</sup>	14 ft <sup>2</sup>
	375 ft <sup>2</sup>	413 ft <sup>2</sup>	443 ft <sup>2</sup>
	13 ft <sup>2</sup>	14 ft <sup>2</sup>	15 ft <sup>2</sup>
	24 ft <sup>2</sup>	26 ft <sup>2</sup>	28 ft <sup>2</sup>
	465 ft <sup>2</sup>	512 ft <sup>2</sup>	549 ft <sup>2</sup>
	8 ft <sup>2</sup>	9 ft <sup>2</sup>	9 ft <sup>2</sup>
	135 ft <sup>2</sup>	149 ft <sup>2</sup>	159 ft <sup>2</sup>
	16 ft <sup>2</sup>	18 ft <sup>2</sup>	19 ft <sup>2</sup>
	197 ft <sup>2</sup>	217 ft <sup>2</sup>	232 ft <sup>2</sup>
	104 ft <sup>2</sup>	114 ft <sup>2</sup>	123 ft <sup>2</sup>
	1736 ft <sup>2</sup>	1911 ft <sup>2</sup>	2048 ft <sup>2</sup>

**+ OPENINGS < 33FT<sup>2</sup>**

	Zero Waste	+10%	+18%
	190 ft <sup>2</sup>	209 ft <sup>2</sup>	224 ft <sup>2</sup>
	26 ft <sup>2</sup>	29 ft <sup>2</sup>	31 ft <sup>2</sup>
	171 ft <sup>2</sup>	188 ft <sup>2</sup>	202 ft <sup>2</sup>
	12 ft <sup>2</sup>	13 ft <sup>2</sup>	14 ft <sup>2</sup>
	375 ft <sup>2</sup>	413 ft <sup>2</sup>	443 ft <sup>2</sup>
	13 ft <sup>2</sup>	14 ft <sup>2</sup>	15 ft <sup>2</sup>
	24 ft <sup>2</sup>	26 ft <sup>2</sup>	28 ft <sup>2</sup>
	485 ft <sup>2</sup>	534 ft <sup>2</sup>	572 ft <sup>2</sup>
	28 ft <sup>2</sup>	31 ft <sup>2</sup>	33 ft <sup>2</sup>
	135 ft <sup>2</sup>	149 ft <sup>2</sup>	159 ft <sup>2</sup>
	16 ft <sup>2</sup>	18 ft <sup>2</sup>	19 ft <sup>2</sup>
	197 ft <sup>2</sup>	217 ft <sup>2</sup>	232 ft <sup>2</sup>
	104 ft <sup>2</sup>	114 ft <sup>2</sup>	123 ft <sup>2</sup>
	1776 ft <sup>2</sup>	1955 ft <sup>2</sup>	2095 ft <sup>2</sup>

The first Siding Waste Factor table is calculated using the total ft<sup>2</sup> of siding facades, ft<sup>2</sup> of trim touching siding, and ft<sup>2</sup> of unknowns touching siding.

The tables above provide the area of siding on a given property, segmented by individual and in sum total form. Values include openings (doors & windows) and waste percentages as noted. Please consider that area values and specific waste factors can be influenced by the size and complexity of the property, captured image quality, specific siding techniques, and your own level of expertise. Accessories are not included in these values and may require additional material.

These tables are only intended to make common waste calculations easier and should not be interpreted as recommendations.

Windows

Group	Group Width x Height	Group United Inches	Opening	Width x Height	United Inches	Area
WG-1	92" x 42"	134"	W-101	20" x 42"	62"	6 ft <sup>2</sup>
			W-102	42" x 40"	82"	12 ft <sup>2</sup>
			W-103	20" x 42"	62"	6 ft <sup>2</sup>
WG-2	89" x 51"	140"	W-104	21" x 50"	71"	7 ft <sup>2</sup>
			W-105	39" x 50"	89"	14 ft <sup>2</sup>
			W-106	21" x 50"	71"	7 ft <sup>2</sup>
WG-3	93" x 49"	142"	W-107	19" x 49"	68"	6 ft <sup>2</sup>
			W-108	44" x 48"	91"	14 ft <sup>2</sup>
			W-109	19" x 49"	68"	6 ft <sup>2</sup>
WG-4	33" x 44"	77"	W-110	33" x 44"	77"	10 ft <sup>2</sup>
WG-5	33" x 44"	77"	W-111	33" x 44"	77"	10 ft <sup>2</sup>
WG-6	27" x 38"	65"	W-112	27" x 38"	65"	7 ft <sup>2</sup>
WG-7	38" x 47"	85"	W-113	38" x 47"	85"	12 ft <sup>2</sup>
WG-8	27" x 38"	65"	W-114	27" x 38"	65"	7 ft <sup>2</sup>
WG-9	29" x 42"	71"	W-115	29" x 42"	71"	8 ft <sup>2</sup>
			Total	-	1104"	132 ft <sup>2</sup>

**Doors**

Opening	Width x Height
D-1	192" x 84"
D-2	36" x 80"
D-3	36" x 80"

\*Door height and width have been snapped to standard

**Entire Doors**

Opening	Width x Height	Area
D-1	188" x 85"	111 ft <sup>2</sup>
D-2	36" x 80"	20 ft <sup>2</sup>
D-3	36" x 80"	20 ft <sup>2</sup>
Total	-	151 ft <sup>2</sup>

\*Total door square footage includes entire door package (e.g. with transoms, sidelites, etc.)



Roof	Length
Ridges (RI)	83' 5"
Hips (H)	41' 5"
Valleys (V)	30' 8"
Rakes (RA)	52' 8"
Eaves (E)	231' 9"
Flashing (F)*	50' 2"
Step Flashing (SF)*	-
Transition Line (TL)	-

\*Please view the 3D model for more detail (e.g. flashing, step flashing and some other roof lines may be difficult to see on the PDF)

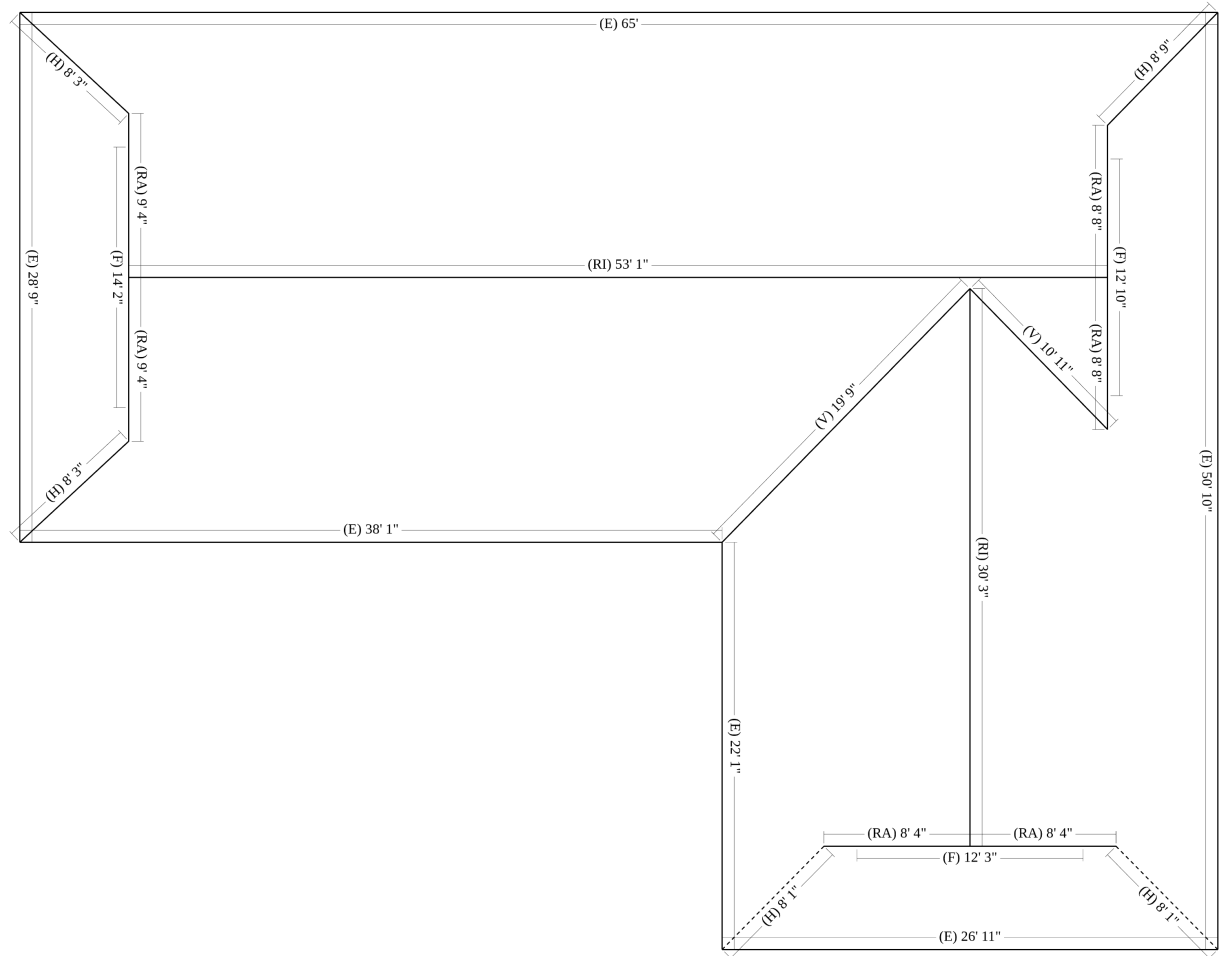

Roof Facets

Facet	Area	Pitch
RF-1	347 ft <sup>2</sup>	4/12
RF-2	126 ft <sup>2</sup>	4/12
RF-3	489 ft <sup>2</sup>	4/12
RF-4	643 ft <sup>2</sup>	4/12
RF-5	143 ft <sup>2</sup>	4/12
RF-6	838 ft <sup>2</sup>	4/12

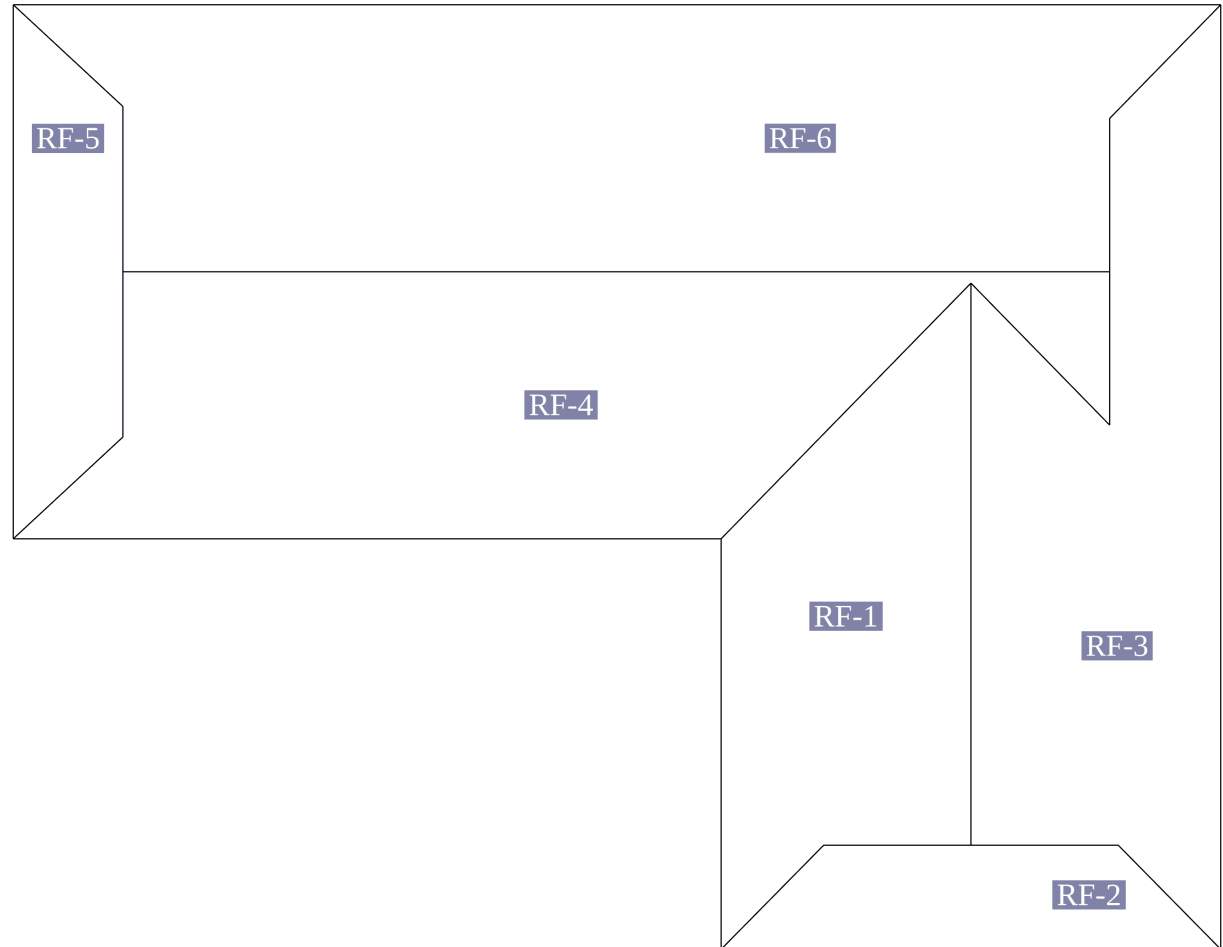

Roof	Facets	Total
Total	6	2586 ft <sup>2</sup>

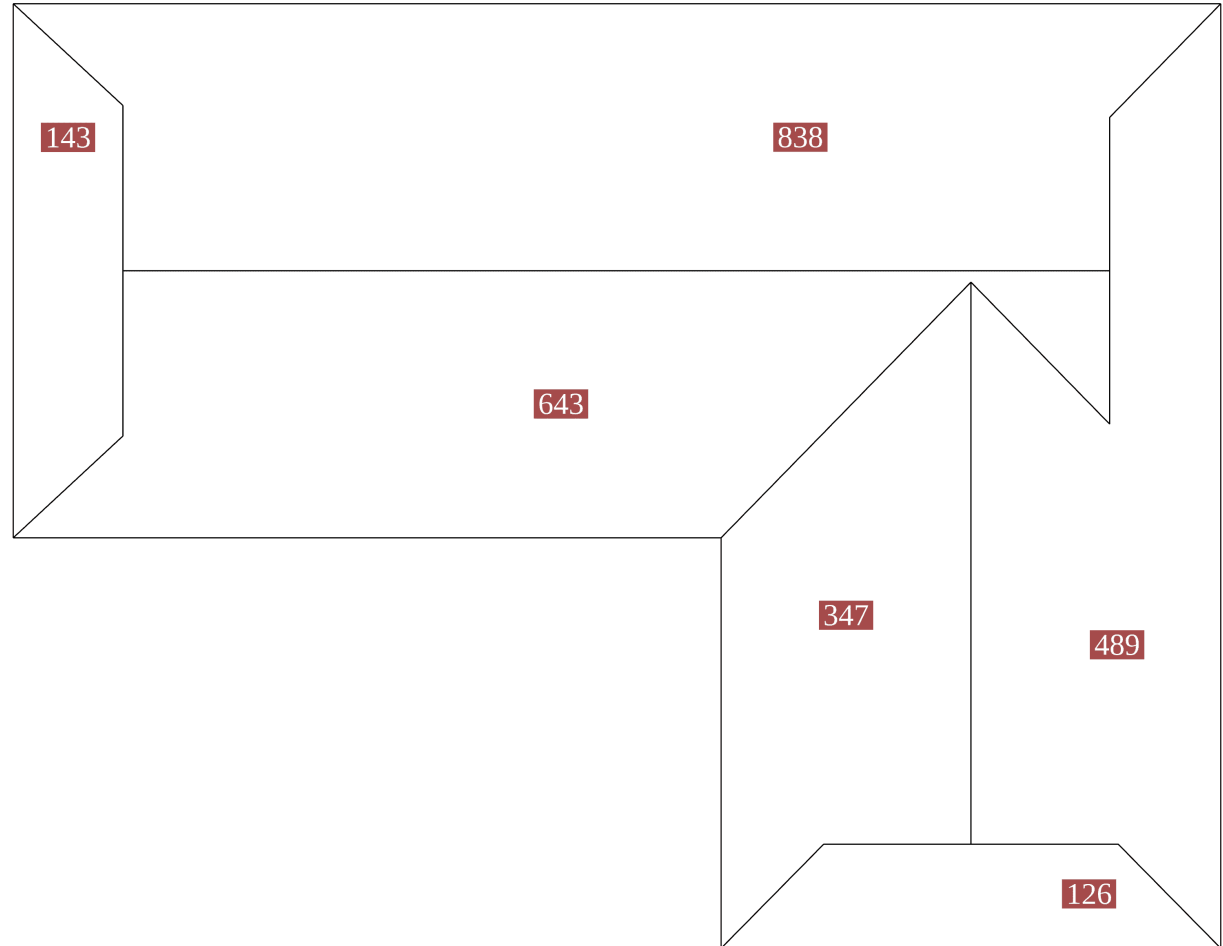

Roof Pitch	Area	Percentage
4 / 12	2586 ft <sup>2</sup>	100%

